

LP2986

Micropower, 200 mA Ultra Low-Dropout Fixed or Adjustable Voltage Regulator

General Description

The LP2986 is a 200 mA precision LDO voltage regulator which offers the designer a higher performance version of the industry standard LP2951.

Using an optimized VIP™ (Vertically Integrated PNP) process, the LP2986 delivers superior performance:

Dropout Voltage: Typically 180 mV @ 200 mA load, and 1 mV @ 1 mA load.

Ground Pin Current: Typically 1 mA @ 200 mA load, and 200 μ A @ 10 mA load.

Sleep Mode: The LP2986 draws less than 1 μ A quiescent current when shutdown pin is pulled low.

Error Flag: The built-in error flag goes low when the output drops approximately 5% below nominal.

Precision Output: The standard product versions available can be pin-strapped (using the internal resistive divider) to provide output voltages of 5.0V, 3.3V, or 3.0V with guaranteed accuracy of 0.5% ("A" grade) and 1% (standard grade) at room temperature.

Features

- Ultra low dropout voltage
- Guaranteed 200 mA output current
- SO-8 and mini-SO8 surface mount packages
- <1 μ A quiescent current when shutdown
- Low ground pin current at all loads
- 0.5% output voltage accuracy ("A" grade)
- High peak current capability (400 mA typical)
- Wide supply voltage range (16V max)
- Overtemperature/overcurrent protection
- -40°C to +125°C junction temperature range

Applications

- Cellular Phone
- Palmtop/Laptop Computer
- Camcorder, Personal Stereo, Camera

Block Diagram

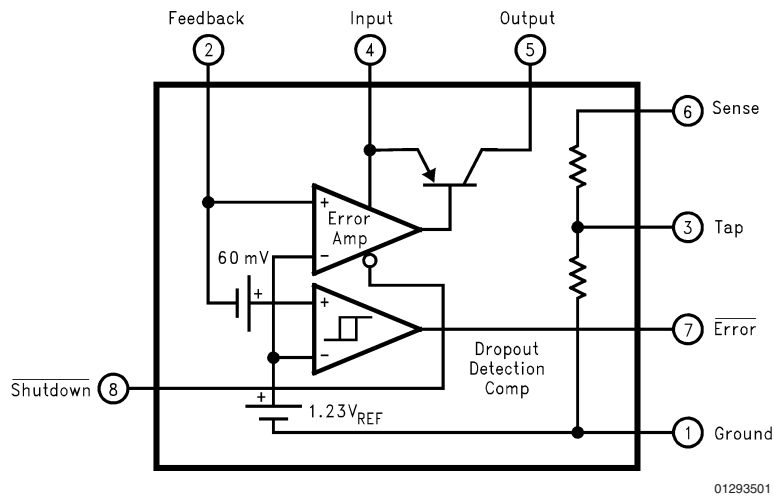

01293501

VIP™ is a trademark of National Semiconductor Corporation.

Connection Diagrams and Ordering Information

Surface Mount Packages:

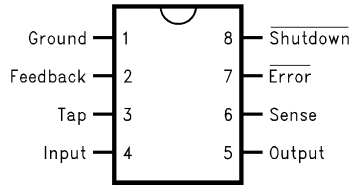

01293502

SO-8/Mini SO-8 Package

See NS Package Drawing Number M08A/MUA08A

8-Lead LLP Surface Mount Package

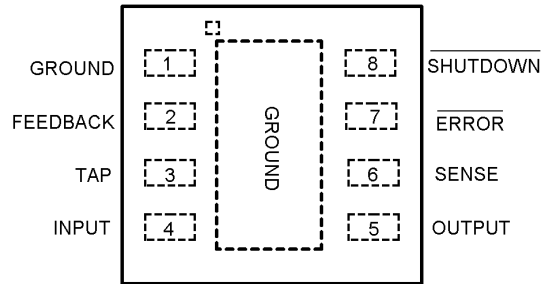

01293543

Top View

See NS Package Drawing Number LDC08A

Basic Application Circuits

Application Using Internal Resistive Divider

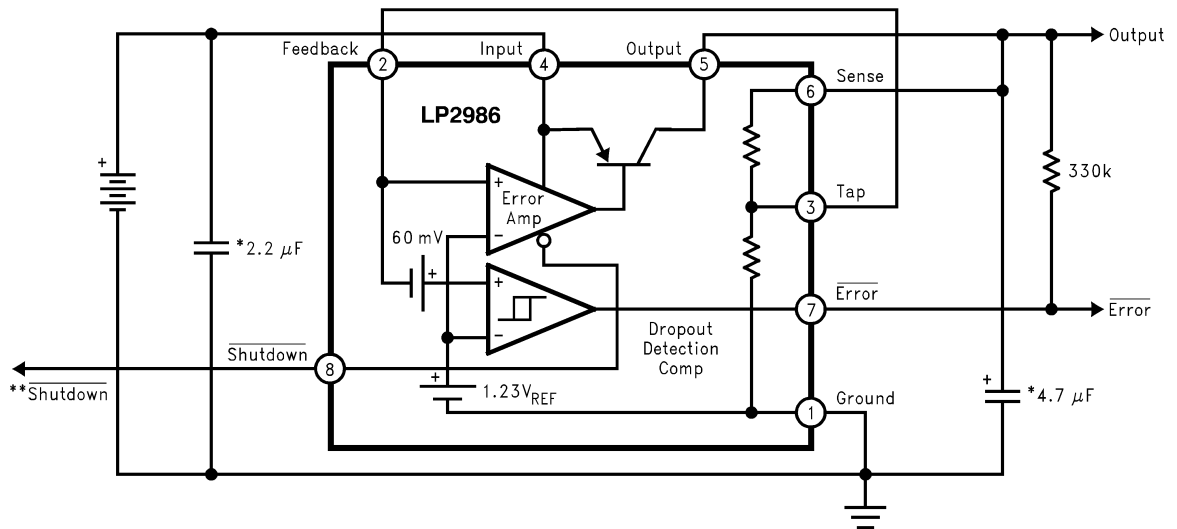

* Minimum capacitance shown to assure stability, but may be increased without limit. Larger output capacitor provides improved dynamic response.

** Shutdown input must be actively terminated. Tie to V_{IN} if not used.

01293503

Basic Application Circuits (Continued)

Application Using External Divider

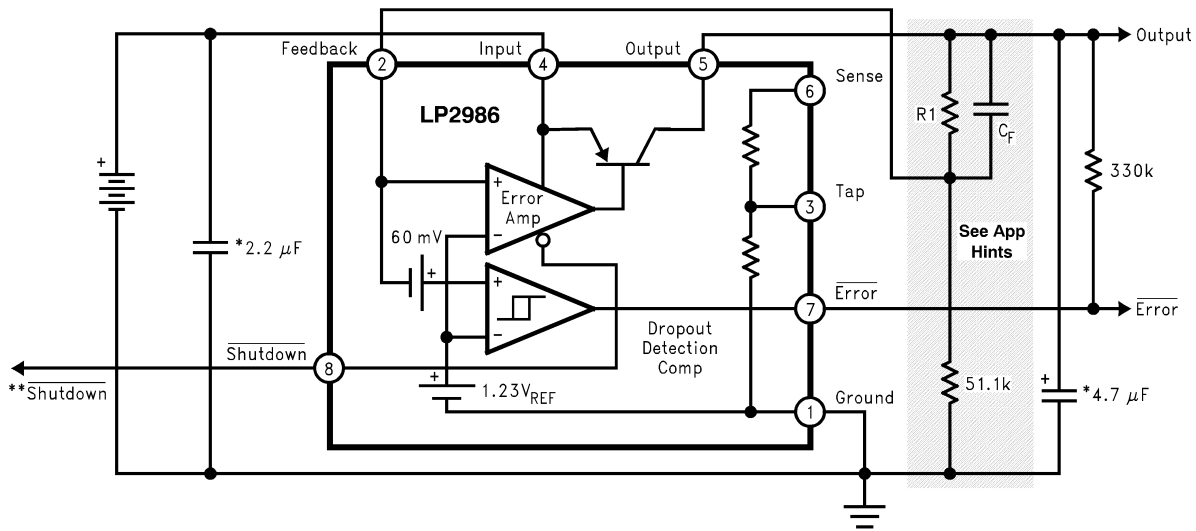

* Minimum capacitance shown to assure stability, but may be increased without limit. Larger output capacitor provides improved dynamic response.

** Shutdown input must be actively terminated. Tie to V_{IN} if not used.

01293504

Ordering Information

TABLE 1. Package Marking and Ordering Information

Output Voltage	Grade	Order Information	Package Marking	Supplied as:
Mini SO-8				
5	A	LP2986AIMMX-5.0	L41A	3500 Units on Tape and Reel
5	A	LP2986AIMM-5.0	L41A	1000 Units on Tape and Reel
5	STD	LP2986IMMX-5.0	L41B	3500 Units on Tape and Reel
5	STD	LP2986IMM-5.0	L41B	1000 Units on Tape and Reel
3.3	A	LP2986AIMMX-3.3	L40A	3500 Units on Tape and Reel
3.3	A	LP2986AIMM-3.3	L40A	1000 Units on Tape and Reel
3.3	STD	LP2986IMMX-3.3	L40B	3500 Units on Tape and Reel
3.3	STD	LP2986IMM-3.3	L40B	1000 Units on Tape and Reel
3.0	A	LP2986AIMMX-3.0	L39A	3500 Units on Tape and Reel
3.0	A	LP2986AIMM-3.0	L39A	1000 Units on Tape and Reel
3.0	STD	LP2986IMMX-3.0	L39B	3500 Units on Tape and Reel
3.0	STD	LP2986IMM-3.0	L39B	1000 Units on Tape and Reel

Ordering Information (Continued)**TABLE 1. Package Marking and Ordering Information** (Continued)

Output Voltage	Grade	Order Information	Package Marking	Supplied as:
SO-8				
5	A	LP2986AIMX-5.0	2986AIM5.0	2500 Units on Tape and Reel
5	A	LP2986AIM-5.0	2986AIM5.0	Shipped in Anti-Static Rails
5	STD	LP2986IMX-5.0	2986IM5.0	2500 Units on Tape and Reel
5	STD	LP2986IM-5.0	2986IM5.0	Shipped in Anti-Static Rails
3.3	A	LP2986AIMX-3.3	2986AIM3.3	2500 Units on Tape and Reel
3.3	A	LP2986AIM-3.3	2986AIM3.3	Shipped in Anti-Static Rails
3.3	STD	LP2986IMX-3.3	2986IM3.3	2500 Units on Tape and Reel
3.3	STD	LP2986IM-3.3	2986IM3.3	Shipped in Anti-Static Rails
3.0	A	LP2986AIMX-3.0	2986AIM3.0	2500 Units on Tape and Reel
3.0	A	LP2986AIM-3.0	2986AIM3.0	Shipped in Anti-Static Rails
3.0	STD	LP2986IMX-3.0	2986IM3.0	2500 Units on Tape and Reel
3.0	STD	LP2986IM-3.0	2986IM3.0	Shipped in Anti-Static Rails
8-Lead LLP				
5	A	LP2986AILD-5	L006A	1000 Units on Tape and Reel
5	A	LP2986AILD-5	L006A	4500 Units on Tape and Reel
5	STD	LP2986ILD-5	L006AB	1000 Units on Tape and Reel
5	STD	LP2986ILD-5	L006AB	4500 Units on Tape and Reel
3.3	A	LP2986AILD-3.3	L005A	1000 Units on Tape and Reel
3.3	A	LP2986AILD-3.3	L005A	4500 Units on Tape and Reel
3.3	STD	LP2986ILD-3.3	L005AB	1000 Units on Tape and Reel
3.3	STD	LP2986ILD-3.3	L005AB	4500 Units on Tape and Reel
3.0	A	LP2986AILD-3.0	L004A	1000 Units on Tape and Reel
3.0	A	LP2986AILD-3.0	L004A	4500 Units on Tape and Reel
3.0	STD	LP2986ILD-3.0	L004AB	1000 Units on Tape and Reel
3.0	STD	LP2986ILD-3.0	L004AB	4500 Units on Tape and Reel

Absolute Maximum Ratings (Note 1)

If Military/Aerospace specified devices are required, please contact the National Semiconductor Sales Office/Distributors for availability and specifications.

Storage Temperature Range	-65°C to +150°C
Operating Junction Temperature Range	-40°C to +125°C
Lead Temperature (Soldering, 5 seconds)	260°C
ESD Rating (Note 2)	2 kV
Power Dissipation (Note 3)	Internally Limited

Input Supply Voltage (Survival)	-0.3V to +16V
Input Supply Voltage (Operating)	2.1V to +16V
Shutdown Pin	-0.3V to +16V
Feedback Pin	-0.3V to +5V
Output Voltage (Survival) (Note 4)	-0.3V to +16V
I _{OUT} (Survival)	Short Circuit Protected
Input-Output Voltage (Survival) (Note 5)	-0.3V to +16V

Electrical Characteristics

Limits in standard typeface are for T_J = 25°C, and limits in **boldface type** apply over the full operating temperature range. Unless otherwise specified: V_{IN} = V_{O(NOM)} + 1V, I_L = 1 mA, C_{OUT} = 4.7 µF, C_{IN} = 2.2 µF, V_{S/D} = 2V.

Symbol	Parameter	Conditions	Typical	LM2986AI-X.X (Note 6)		LM2986I-X.X (Note 6)		Units	
				Min	Max	Min	Max		
V _O	Output Voltage (5.0V Versions)	0.1 mA < I _L < 200 mA	5.0	4.975	5.025	4.950	5.050	V	
			5.0	4.960	5.040	4.920	5.080		
				4.910	5.090	4.860	5.140		
	Output Voltage (3.3V Versions)	0.1 mA < I _L < 200 mA	3.3	3.283	3.317	3.267	3.333		
			3.3	3.274	3.326	3.247	3.353		
				3.241	3.359	3.208	3.392		
Output Voltage (3.0V Versions)	0.1 mA < I _L < 200 mA	3.0	2.985	3.015	2.970	3.030			
		3.0	2.976	3.024	2.952	3.048			
			2.946	3.054	2.916	3.084			
$\frac{V_O}{\Delta V_{IN}}$	Output Voltage Line Regulation	V _{O(NOM)} + 1V ≤ V _{IN} ≤ 16V	0.007		0.014		0.014	%V	
					0.032		0.032		
V _{IN} -V _O	Dropout Voltage (Note 7)	I _L = 100 µA	1		2.0		2.0	mV	
				3.5		3.5			
		I _L = 75 mA		90		120			120
					170		170		
I _{GND}	Ground Pin Current	I _L = 100 µA	100		120		120	µA	
				150		150			
		I _L = 75 mA		500		800			800
					1400		1400		
I _{O(PK)}	Peak Output Current	V _{OUT} ≥ V _{O(NOM)} - 5%	400	250			250	mA	
I _{O(MAX)}	Short Circuit Current	R _L = 0 (Steady State) (Note 11)	400						
e _n	Output Noise Voltage (RMS)	BW = 300 Hz to 50 kHz, C _{OUT} = 10 µF	160					µV(RMS)	
$\frac{\Delta V_{OUT}}{\Delta V_{IN}}$	Ripple Rejection	f = 1 kHz, C _{OUT} = 10 µF	65					dB	
$\frac{\Delta V_{OUT}}{\Delta T}$	Output Voltage Temperature Coefficient	(Note 9)	20					ppm/°C	

Electrical Characteristics (Continued)

Limits in standard typeface are for $T_J = 25^\circ\text{C}$, and limits in **boldface type** apply over the full operating temperature range. Unless otherwise specified: $V_{IN} = V_O(\text{NOM}) + 1\text{V}$, $I_L = 1\text{ mA}$, $C_{OUT} = 4.7\ \mu\text{F}$, $C_{IN} = 2.2\ \mu\text{F}$, $V_{S/D} = 2\text{V}$.

Symbol	Parameter	Conditions	Typical	LM2986AI-X.X (Note 6)		LM2986I-X.X (Note 6)		Units
				Min	Max	Min	Max	
FEEDBACK PIN								
V_{FB}	Feedback Pin Voltage		1.23	1.21	1.25	1.20	1.26	V
		(Note 10)	1.23	1.20	1.26	1.19	1.27	
$\frac{\Delta V_{FB}}{\Delta T}$	FB Pin Voltage Temperature Coefficient	(Note 9)	20					ppm/ $^\circ\text{C}$
I_{FB}	Feedback Pin Bias Current	$I_L = 200\text{ mA}$	150		330		330	nA
					760		760	
$\frac{I_{FB}}{\Delta T}$	FB Pin Bias Current Temperature Coefficient	(Note 9)	0.1					nA/ $^\circ\text{C}$
SHUTDOWN INPUT								
$V_{S/D}$	S/D Input Voltage (Note 8)	$V_H = \text{O/P ON}$	1.4	1.6		1.6		V
		$V_L = \text{O/P OFF}$	0.55		0.18		0.18	
$I_{S/D}$	S/D Input Current	$V_{S/D} = 0$	0		-1		-1	μA
		$V_{S/D} = 5\text{V}$	5		15		15	
ERROR COMPARATOR								
I_{OH}	Output "HIGH" Leakage	$V_{OH} = 16\text{V}$	0.01		1		1	μA
V_{OL}	Output "LOW" Voltage	$V_{IN} = V_O(\text{NOM}) - 0.5\text{V}$, $I_O(\text{COMP}) = 300\ \mu\text{A}$	150		220		220	mV
					350		350	
$V_{THR}(\text{MAX})$	Upper Threshold Voltage		-4.6	-5.5	-3.5	-5.5	-3.5	% V_{OUT}
$V_{THR}(\text{MIN})$	Lower Threshold Voltage		-6.6	-7.7	-2.5	-7.7	-2.5	
				-13.0	-3.3	-13.0	-3.3	
HYST	Hysteresis		2.0					

Electrical Characteristics (Continued)

Note 1: Absolute Maximum Ratings indicate limits beyond which damage to the component may occur. Electrical specifications do not apply when operating the device outside of its rated operating conditions.

Note 2: The ESD rating of the Feedback pin is 500V. The ESD rating of the V_{IN} pin is 1kV and the Tap pin is 1.5 kV.

Note 3: The maximum allowable power dissipation is a function of the maximum junction temperature, $T_J(\text{MAX})$, the junction-to-ambient thermal resistance, θ_{J-A} , and the ambient temperature, T_A . The maximum allowable power dissipation at any ambient temperature is calculated using:

$$P(\text{MAX}) = \frac{T_J(\text{MAX}) - T_A}{\theta_{J-A}}$$

The value of θ_{J-A} for the SO-8 (M) package is 160°C/W, and the mini SO-8 (MM) package is 200°C/W. The value θ_{J-A} for the LLP (LD) package is specifically dependent on PCB trace area, trace material, and the number of layers and thermal vias. For improved thermal resistance and power dissipation for the LLP package, refer to Application Note AN-1187. Exceeding the maximum allowable power dissipation will cause excessive die temperature, and the regulator will go into thermal shutdown.

Note 4: If used in a dual-supply system where the regulator load is returned to a negative supply, the LM2986 output must be diode-clamped to ground.

Note 5: The output PNP structure contains a diode between the V_{IN} and V_{OUT} terminals that is normally reverse-biased. Forcing the output above the input will turn on this diode and may induce a latch-up mode which can damage the part (see Application Hints).

Note 6: Limits are 100% production tested at 25°C. Limits over the operating temperature range are guaranteed through correlation using Statistical Quality Control (SQC) methods. The limits are used to calculate National's Average Outgoing Quality Level (AOQL).

Note 7: Dropout voltage is defined as the input to output differential at which the output voltage drops 100 mV below the value measured with a 1V differential.

Note 8: To prevent mis-operation, the Shutdown input must be driven by a signal that swings above V_H and below V_L with a slew rate not less than 40 mV/ μ s (see Application Hints).

Note 9: Temperature coefficient is defined as the maximum (worst-case) change divided by the total temperature range.

Note 10: $V_{FB} \leq V_{OUT} \leq (V_{IN} - 1)$, $2.5V \leq V_{IN} \leq 16V$, $100 \mu A \leq I_L \leq 200 \text{ mA}$, $T_J \leq 125^\circ\text{C}$.

Note 11: See Typical Performance Characteristics curves.

Typical Performance Characteristics Unless otherwise specified: $T_A = 25^\circ\text{C}$, $C_{OUT} = 4.7 \mu\text{F}$, $C_{IN} = 2.2 \mu\text{F}$, S/D is tied to V_{IN} , $V_{IN} = V_{O(NOM)} + 1\text{V}$, $I_L = 1 \text{mA}$.

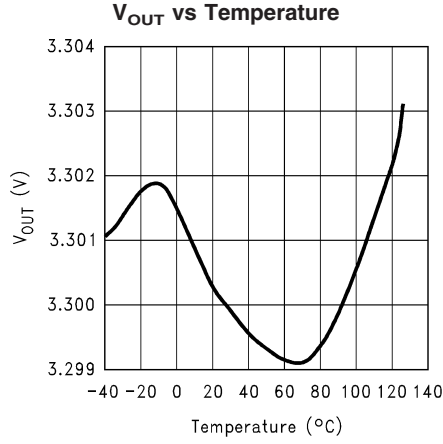

01293508

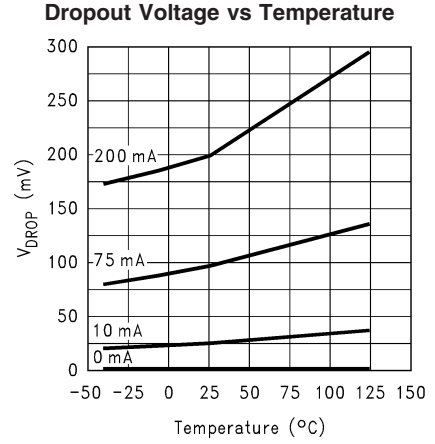

01293509

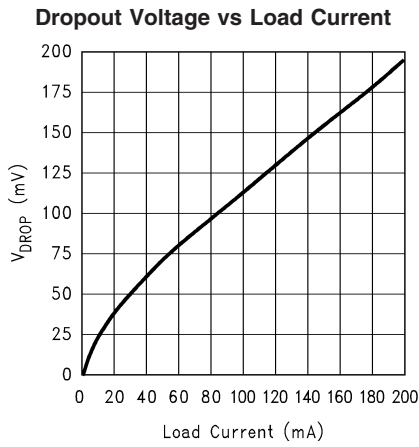

01293510

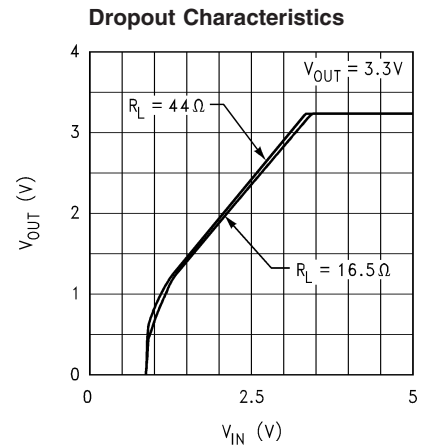

01293513

Ground Pin Current vs Temperature and Load

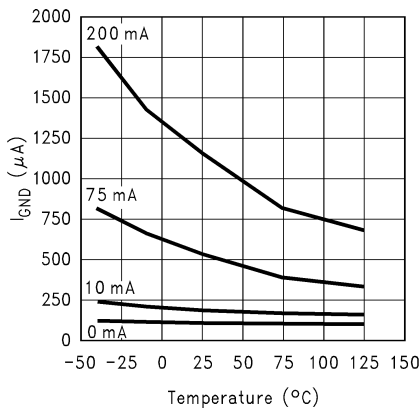

01293512

Ground Pin Current vs Load Current

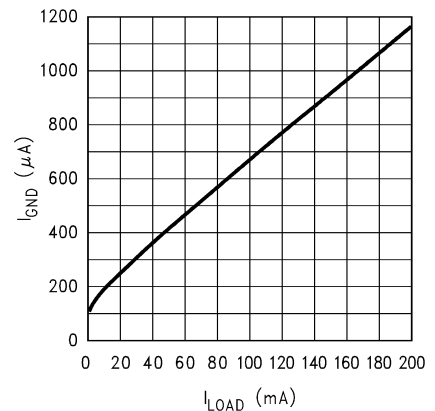

01293511

Typical Performance Characteristics Unless otherwise specified: $T_A = 25^\circ\text{C}$, $C_{OUT} = 4.7 \mu\text{F}$, $C_{IN} = 2.2 \mu\text{F}$, S/D is tied to V_{IN} , $V_{IN} = V_{O(NOM)} + 1\text{V}$, $I_L = 1\text{mA}$. (Continued)

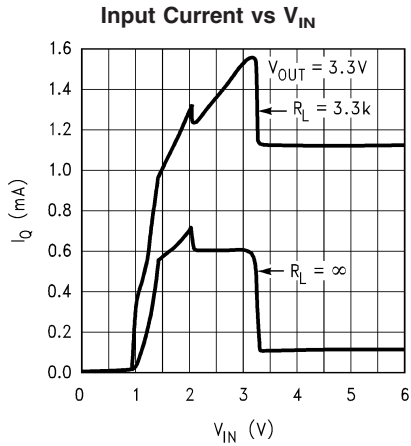

01293514

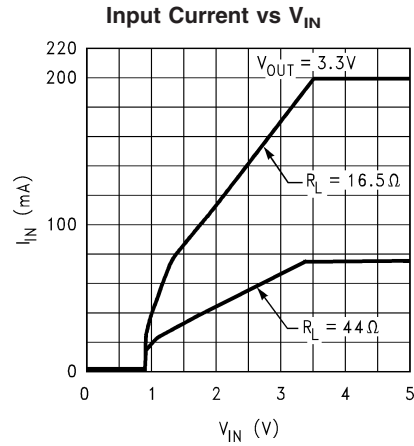

01293515

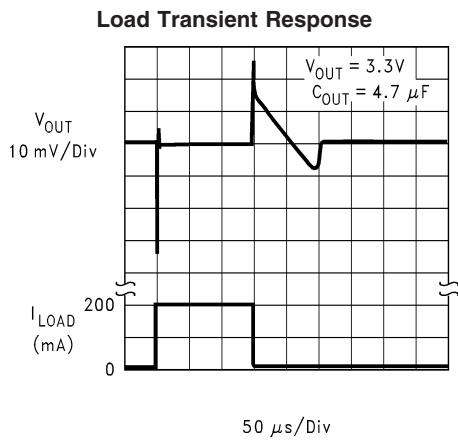

01293516

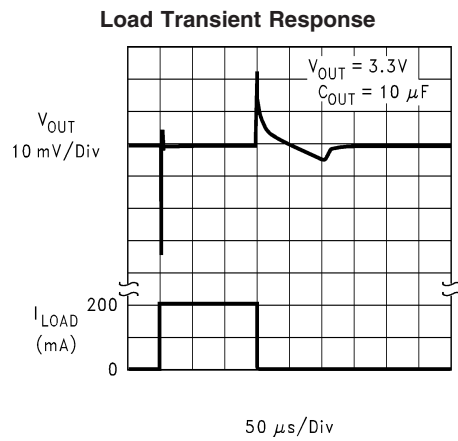

01293517

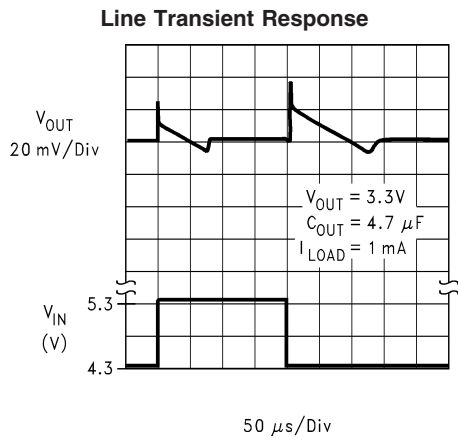

01293518

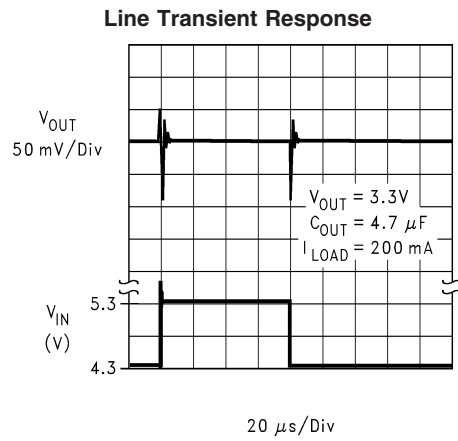

01293520

Typical Performance Characteristics Unless otherwise specified: $T_A = 25^\circ\text{C}$, $C_{OUT} = 4.7 \mu\text{F}$, $C_{IN} = 2.2 \mu\text{F}$, S/D is tied to V_{IN} , $V_{IN} = V_{O(NOM)} + 1\text{V}$, $I_L = 1 \text{mA}$. (Continued)

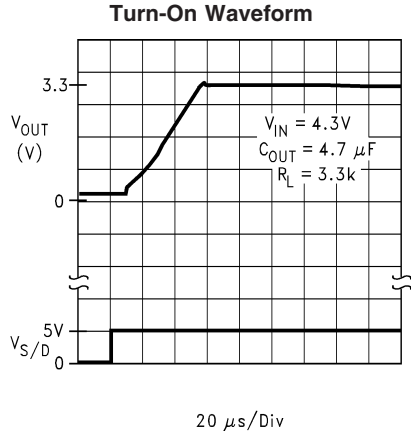

01293521

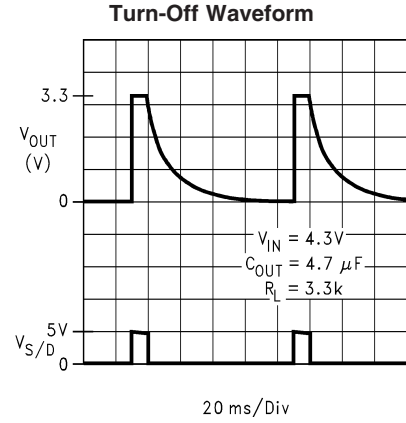

01293523

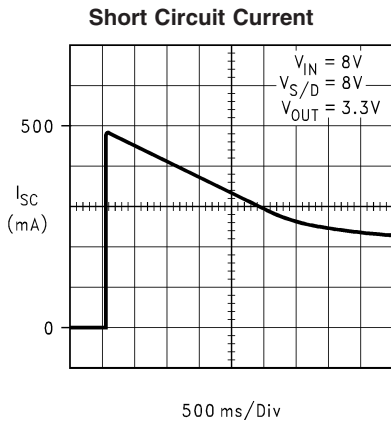

01293524

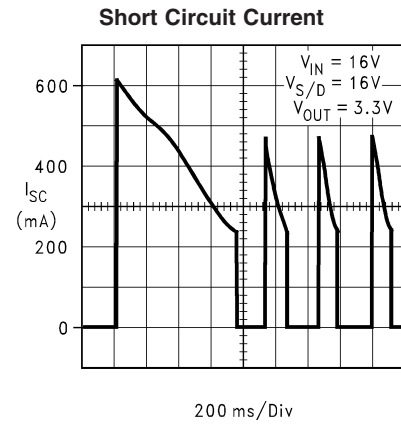

01293525

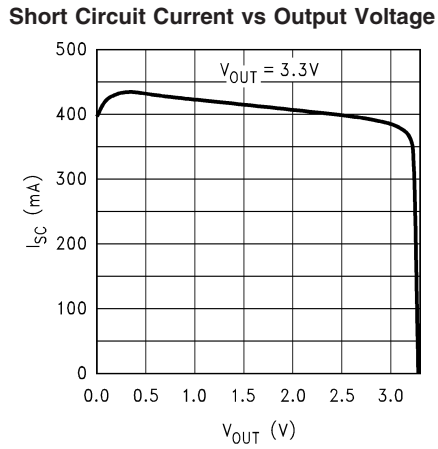

01293526

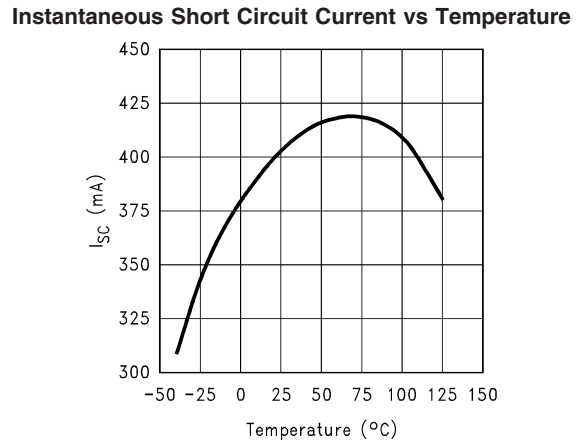

01293527

Typical Performance Characteristics Unless otherwise specified: $T_A = 25^\circ\text{C}$, $C_{OUT} = 4.7 \mu\text{F}$, $C_{IN} = 2.2 \mu\text{F}$, S/D is tied to V_{IN} , $V_{IN} = V_{O(NOM)} + 1\text{V}$, $I_L = 1 \text{mA}$. (Continued)

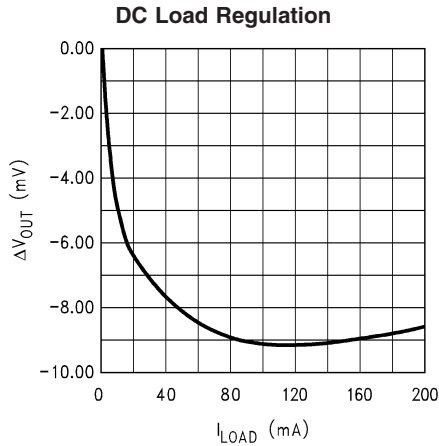

01293528

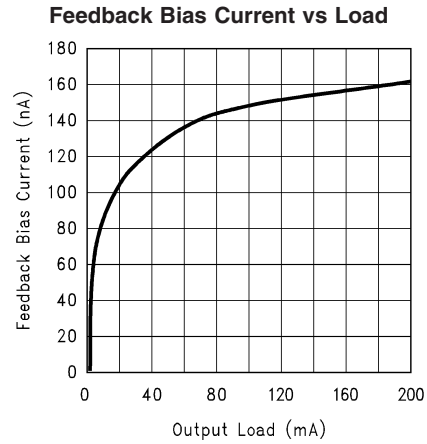

01293529

Feedback Bias Current vs Temperature

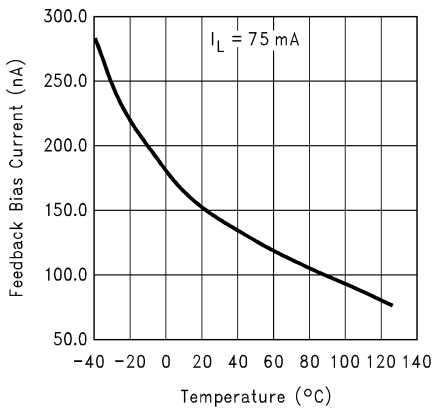

01293530

Shutdown Pin Current vs Shutdown Pin Voltage

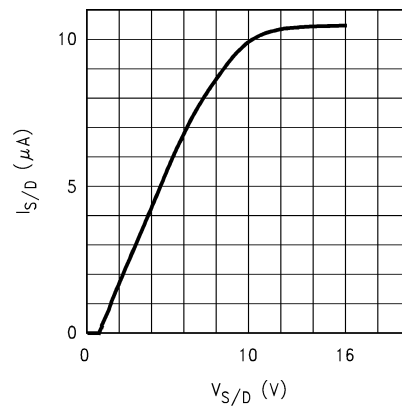

01293531

Shutdown Voltage vs Temperature

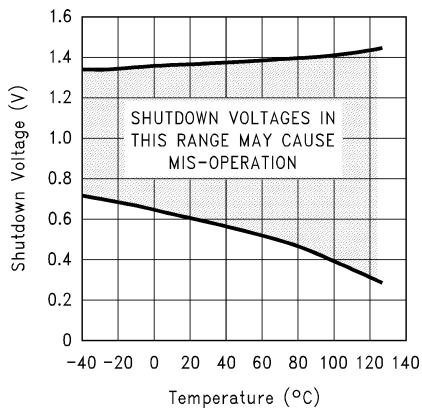

01293532

Input to Output Leakage vs Temperature

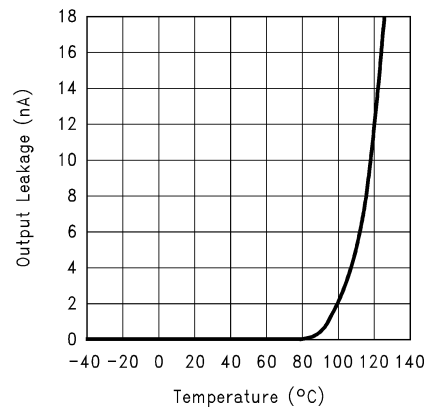

01293537

Typical Performance Characteristics Unless otherwise specified: $T_A = 25^\circ\text{C}$, $C_{OUT} = 4.7 \mu\text{F}$, $C_{IN} = 2.2 \mu\text{F}$, S/D is tied to V_{IN} , $V_{IN} = V_{O(NOM)} + 1\text{V}$, $I_L = 1 \text{mA}$. (Continued)

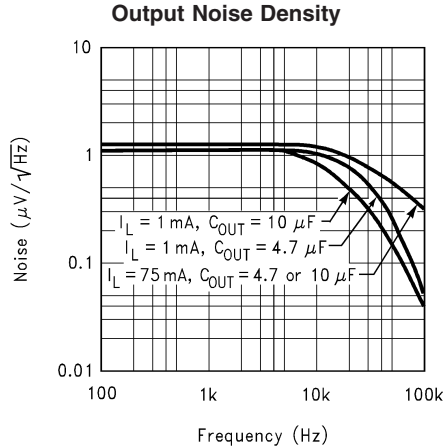

01293534

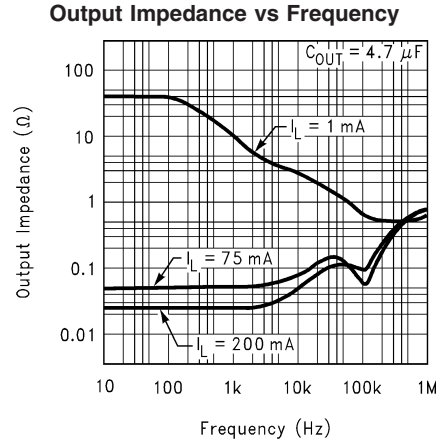

01293535

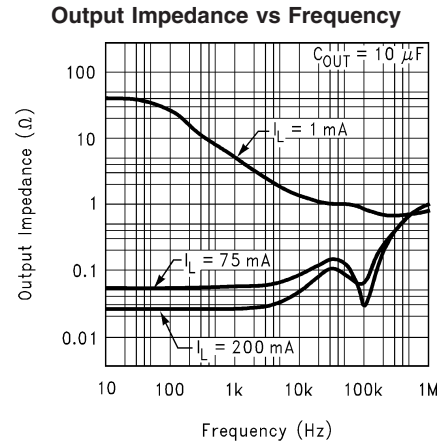

01293536

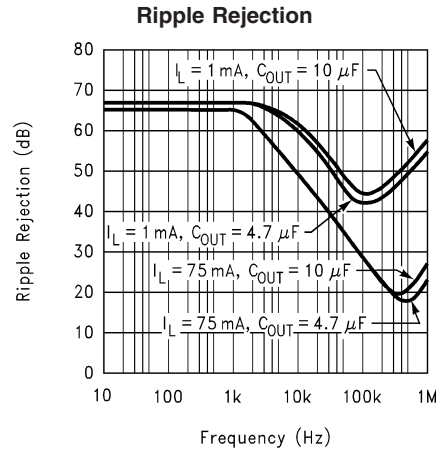

01293533

Application Hints

LLP Package Devices

The LP2986 is offered in the 8 lead LLP surface mount package to allow for increased power dissipation compared to the SO-8 and Mini SO-8. For details on thermal performance as well as mounting and soldering specifications, refer to Application Note AN-1187.

EXTERNAL CAPACITORS

Like any low-dropout regulator, external capacitors are required to assure stability. These capacitors must be correctly selected for proper performance.

INPUT CAPACITOR: An input capacitor ($\geq 2.2 \mu\text{F}$) is required between the LP2986 input and ground (amount of capacitance may be increased without limit).

This capacitor must be located a distance of not more than 0.5" from the input pin and returned to a clean analog ground. Any good quality ceramic or tantalum may be used for this capacitor.

OUTPUT CAPACITOR: The output capacitor must meet the requirement for minimum amount of capacitance and also have an appropriate E.S.R. (equivalent series resistance) value.

Curves are provided which show the allowable ESR range as a function of load current for various output voltages and capacitor values (see ESR curves below).

ESR Curves For 5V Output

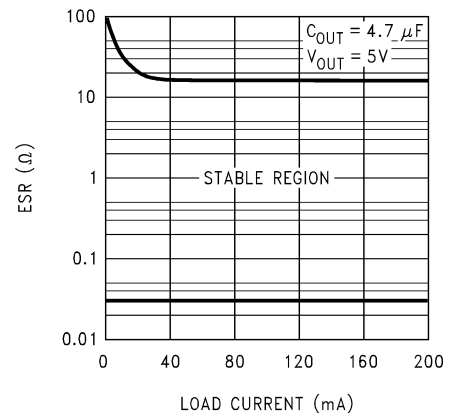

01293506

Application Hints (Continued)

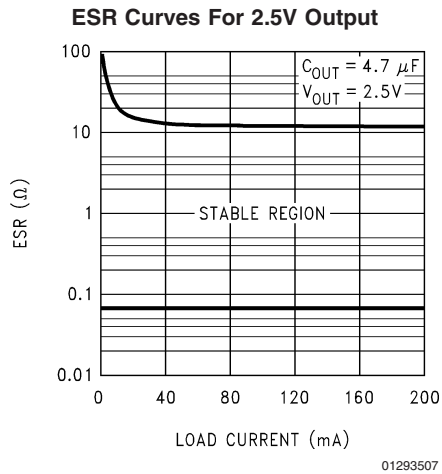

IMPORTANT: The output capacitor must maintain its ESR in the stable region over the full operating temperature range of the application to assure stability.

The minimum required amount of output capacitance is 4.7 μF . Output capacitor size can be increased without limit. It is important to remember that capacitor tolerance and variation with temperature must be taken into consideration when selecting an output capacitor so that the minimum required amount of output capacitance is provided over the full operating temperature range. A good Tantalum capacitor will show very little variation with temperature, but a ceramic may not be as good (see next section).

CAPACITOR CHARACTERISTICS

TANTALUM: The best choice for size, cost, and performance are solid tantalum capacitors. Available from many sources, their typical ESR is very close to the ideal value required on the output of many LDO regulators.

Tantalums also have good temperature stability: a 4.7 μF was tested and showed only a 10% decline in capacitance as the temperature was decreased from +125°C to -40°C. The ESR increased only about 2:1 over the same range of temperature.

However, it should be noted that the increasing ESR at lower temperatures present in all tantalums can cause oscillations when marginal quality capacitors are used (where the ESR of the capacitor is near the upper limit of the stability range at room temperature).

CERAMIC: For a given amount of a capacitance, ceramics are usually larger and more costly than tantalums.

Be warned that the ESR of a ceramic capacitor can be low enough to cause instability: a 2.2 μF ceramic was measured and found to have an ESR of about 15 m Ω .

If a ceramic capacitor is to be used on the LP2986 output, a 1 Ω resistor should be placed in series with the capacitor to provide a minimum ESR for the regulator.

Another disadvantage of ceramic capacitors is that their capacitance varies a lot with temperature:

Large ceramic capacitors are typically manufactured with the Z5U temperature characteristic, which results in the capacitance dropping by a 50% as the temperature goes from 25°C to 80°C.

This means you have to buy a capacitor with twice the minimum C_{OUT} to assure stable operation up to 80°C.

ALUMINUM: The large physical size of aluminum electrolytics makes them unattractive for use with the LP2986. Their ESR characteristics are also not well suited to the requirements of LDO regulators.

The ESR of an aluminum electrolytic is higher than a tantalum, and it also varies greatly with temperature.

A typical aluminum electrolytic can exhibit an ESR increase of 50X when going from 20°C to -40°C. Also, some aluminum electrolytics can not be used below -25°C because the electrolyte will freeze.

USING AN EXTERNAL RESISTIVE DIVIDER

The LP2986 output voltage can be programmed using an external resistive divider (see Basic Application Circuits).

The resistor connected between the Feedback pin and ground should be 51.1k. The value for the other resistor (R1) connected between the Feedback pin and the regulated output is found using the formula:

$$V_{\text{OUT}} = 1.23 \times (1 + R1/51.1k)$$

It should be noted that the 25 μA of current flowing through the external divider is approximately equal to the current saved by not connecting the internal divider, which means the quiescent current is not increased by using external resistors.

A lead compensation capacitor (C_F) must also be used to place a zero in the loop response at about 50 kHz. The value for C_F can be found using:

$$C_F = 1/(2\pi \times R1 \times 50k)$$

A good quality capacitor must be used for C_F to ensure that the value is accurate and does not change significantly over temperature. Mica or ceramic capacitors can be used, assuming a tolerance of $\pm 20\%$ or better is selected.

If a ceramic is used, select one with a temperature coefficient of NPO, COG, Y5P, or X7R. Capacitor types Z5U, Y5V, and Z4V can not be used because their value varies more than 50% over the -25°C to +85°C temperature range.

SHUTDOWN INPUT OPERATION

The LP2986 is shut off by driving the Shutdown input low, and turned on by pulling it high. If this feature is not to be used, the Shutdown input should be tied to V_{IN} to keep the regulator output on at all times.

To assure proper operation, the signal source used to drive the Shutdown input must be able to swing above and below the specified turn-on/turn-off voltage thresholds listed as V_{H} and V_{L} , respectively (see Electrical Characteristics).

It is also important that the turn-on (and turn-off) voltage signals applied to the Shutdown input have a slew rate which is not less than 40 mV/ μs .

CAUTION: the regulator output state can not be guaranteed if a slow-moving AC (or DC) signal is applied that is in the range between V_{H} and V_{L} .

REVERSE INPUT-OUTPUT VOLTAGE

The PNP power transistor used as the pass element in the LP2986 has an inherent diode connected between the regulator output and input.

During normal operation (where the input voltage is higher than the output) this diode is reverse-biased.

However, if the output is pulled above the input, this diode will turn ON and current will flow into the regulator output.

Application Hints (Continued)

In such cases, a parasitic SCR can latch which will allow a high current to flow into V_{IN} (and out the ground pin), which can damage the part.

In any application where the output may be pulled above the input, an external Schottky diode must be connected from V_{IN} to V_{OUT} (cathode on V_{IN} , anode on V_{OUT}), to limit the reverse voltage across the LP2986 to 0.3V (see Absolute Maximum Ratings).

Physical Dimensions inches (millimeters)

unless otherwise noted

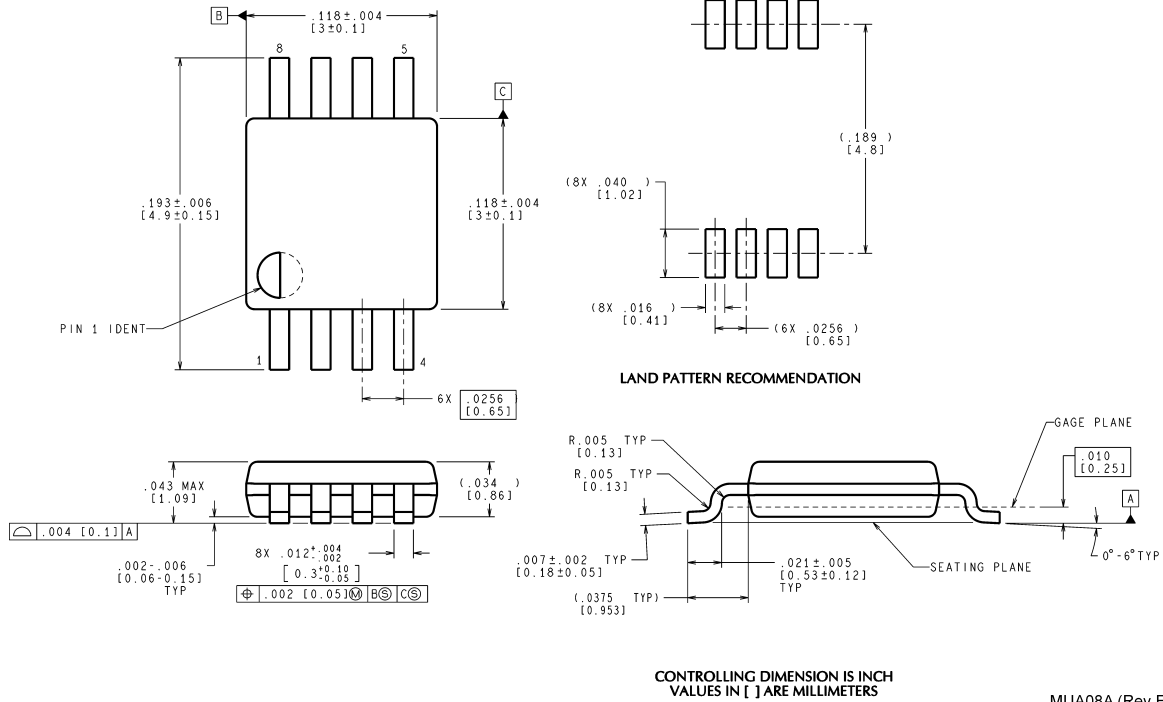

**8-Lead Mini-Small Outline Molded Package, JEDEC
NS Package Number MUA08A**

MUA08A (Rev E)

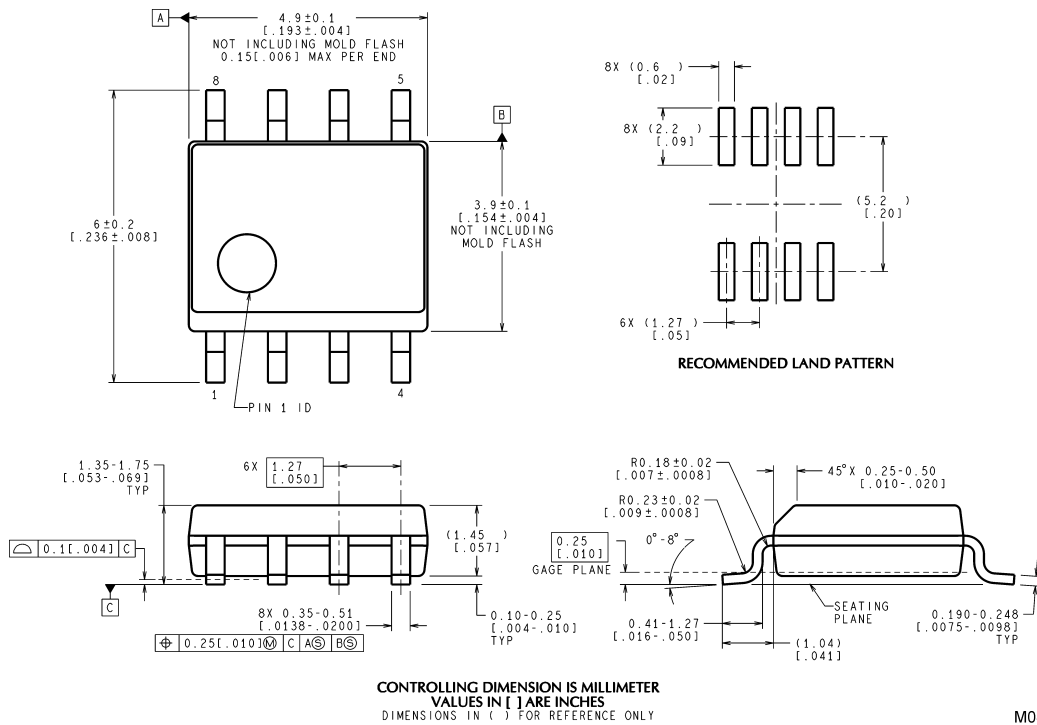

**8-Lead (0.150" Wide) Molded Small Outline Package, JEDEC
NS Package Number M08A**

M08A (Rev K)

Physical Dimensions inches (millimeters) unless otherwise noted (Continued)

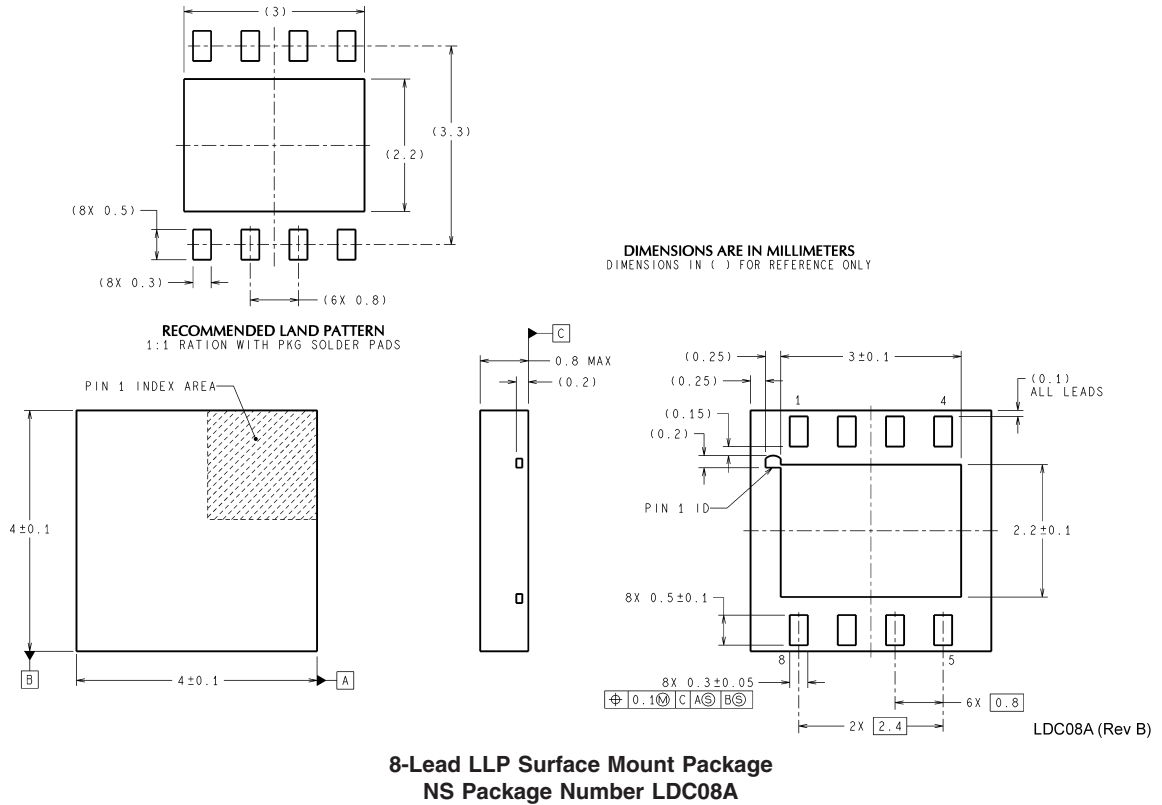

National does not assume any responsibility for use of any circuitry described, no circuit patent licenses are implied and National reserves the right at any time without notice to change said circuitry and specifications.

For the most current product information visit us at www.national.com.

LIFE SUPPORT POLICY

NATIONAL'S PRODUCTS ARE NOT AUTHORIZED FOR USE AS CRITICAL COMPONENTS IN LIFE SUPPORT DEVICES OR SYSTEMS WITHOUT THE EXPRESS WRITTEN APPROVAL OF THE PRESIDENT AND GENERAL COUNSEL OF NATIONAL SEMICONDUCTOR CORPORATION. As used herein:

1. Life support devices or systems are devices or systems which, (a) are intended for surgical implant into the body, or (b) support or sustain life, and whose failure to perform when properly used in accordance with instructions for use provided in the labeling, can be reasonably expected to result in a significant injury to the user.
2. A critical component is any component of a life support device or system whose failure to perform can be reasonably expected to cause the failure of the life support device or system, or to affect its safety or effectiveness.

BANNED SUBSTANCE COMPLIANCE

National Semiconductor manufactures products and uses packing materials that meet the provisions of the Customer Products Stewardship Specification (CSP-9-111C2) and the Banned Substances and Materials of Interest Specification (CSP-9-111S2) and contain no "Banned Substances" as defined in CSP-9-111S2.

 **National Semiconductor**
Americas Customer
Support Center
Email: new.feedback@nsc.com
Tel: 1-800-272-9959

National Semiconductor
Europe Customer Support Center
Fax: +49 (0) 180-530 85 86
Email: europe.support@nsc.com
Deutsch Tel: +49 (0) 69 9508 6208
English Tel: +44 (0) 870 24 0 2171
Français Tel: +33 (0) 1 41 91 8790

National Semiconductor
Asia Pacific Customer
Support Center
Email: ap.support@nsc.com

National Semiconductor
Japan Customer Support Center
Fax: 81-3-5639-7507
Email: jpn.feedback@nsc.com
Tel: 81-3-5639-7560